

Jenco 4" Slim Panel Light

SLIM SURFACE

4" Square LED Slim Profile Recess Retrofit,9W,Airtight

Recess Lighting

Job Information		
Project Name		Type
Location		
Quantity		Date
Contact/Phone		
Notes		

Features

Body

Durable airtight aluminum body with etched white polycarbonate diffuser lens for low glare.

LED Characteristics

This general application light fixture features a 9 watt LED module that maintains uniform intensity producing up to 550 lumens ;with a typical CRI of 90 and a 50,000 hour life span .Available in 3000K or 4000K color temperature

Dimming

100%-10% dimming capability .This fixture is compatible with industry standard TRIAC/ELV dimmers (contact factory for listing of compatible dimmers).

Beam Spread

The fixture lens provides 120° beam spread.

Mounting

Includes two spring loaded clips to attached to any ceiling material .The slim profile allows to be mounted under joists or duct work.

LED Driver

Extruded aluminum hardwire box with 210mA dimmable class II electronic LED driver with 100-135V AC input. Includes an 7" cable from driver to fixture.

Operating Temperature

-20°C~40°C

Environment

Suitable for damp locations. Suitable for insulated ceiling applications.

SPECIFICATION

Application	Ceiling Recess Mount
Approved Location	Damp
Beam Angle	120°
CCT	3000° K / 4000° K
Certification	cETLus
Class II	Yes
Colour	BK / BN / WH
CRI	90
Dimming	Yes
Dimming Tech	TRIAC/ELV
Input	100-135V AC, 60Hz, 0.09A
LM79	Yes
LM80	Yes
Lumens	500
Lumens per Watt	55.6
Power Factor	>0.95
Projected Life	70% @ 50,000 hrs
Warranty	Lifetime
Wattage	9W

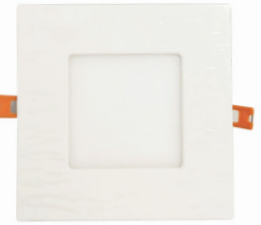

Description

The panel is a 9 watt 4" slim profile light fixture for recess retrofit application. It is a high-performance, easy to install residential grade downlight solution that offers good light output energy efficiency and streamlined design. Suitable for damp locations. For use in soffits.

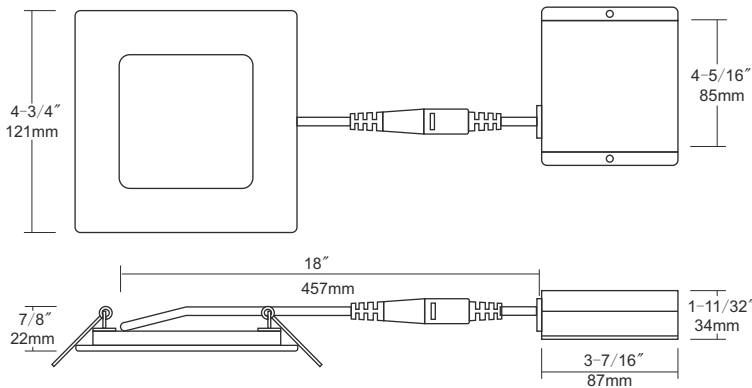



Notes : Accessories are sold separately. For additional options please consult your representative . Due to our continued efforts to improve our products , products specifications are subject to change without notice.

Ordering Guide

LED-S9W-	Colour Temperature	-	Trim Finish	-	SQUARE
	30 : 3000° K 40 : 4000° K		BK : Black BN : Brushed Nickel WH :White		

Accessories

-  **FLEX-10**
10" Flexible connector, for use with Slim LED fixtures.
-  **MP4**
4-1/4" Square pre-mounting plate for Slim LED round fixtures.

Model No.	Delivered Lumens (lm)	Input Watts (W)	Voltage (V)	Colour Temp. (K)	Certification
JC-LED-S9W-3KWH-S	500	9	120	3000K	
JC-LED-S9W-4KWH-S	500	9	120	4000K	
JC-LED-S9W-6KWH-S	500	9	120	6000K	
White					

Photometry

JC-LED-S9W-*K*WH-S : 4" Slim Surface, 3000° K(SQUARE).

Zonal Lumen Summary

Zone	Lumens	% Luminaire
0-30	222.0	29%
0-40	358.7	46.9%
0-60	616.6	80.6%
60-90	148.7	19.4%
70-100	60.3	7.9%
90-120	0	0%
0-90	568.3	100%
90-180	0	0%
0-180	765.3	100%

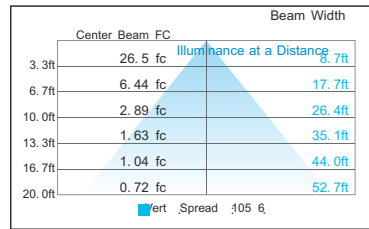
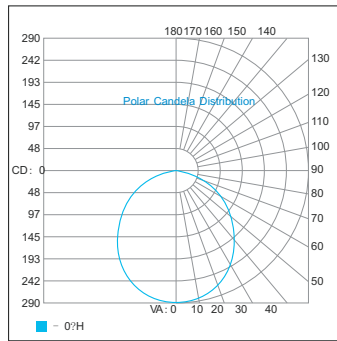

Compatible Dimmers

Brand	Model	Maximum Number of Fixtures per Dimmer
Lutron	DVCL-153P	11
	CTCL-153P	11
	DVELV-300P	24
	SELV-300P	24
	NTELV-300	24
	NTELV-600	48
	MAELV-600	48
	MRF2-6ND-120	12
	DV600	8
Leviton	VPE04	12
	6615	22
	VPE06	45
	VRE06	45
	6672	4
	6674	4
	IPE04	10
	6631	10
	6633-P	10
Cooper	SAL06P-W-K	10